

Uno 4 =mm

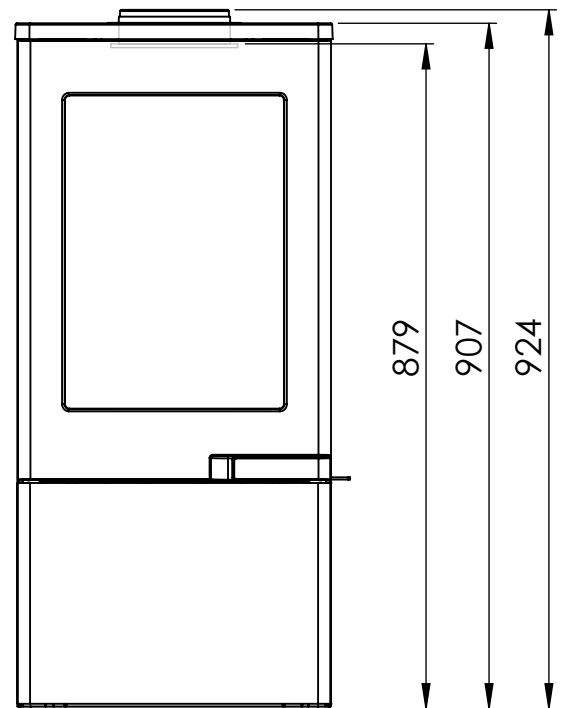

Uno 4 =mm AIR

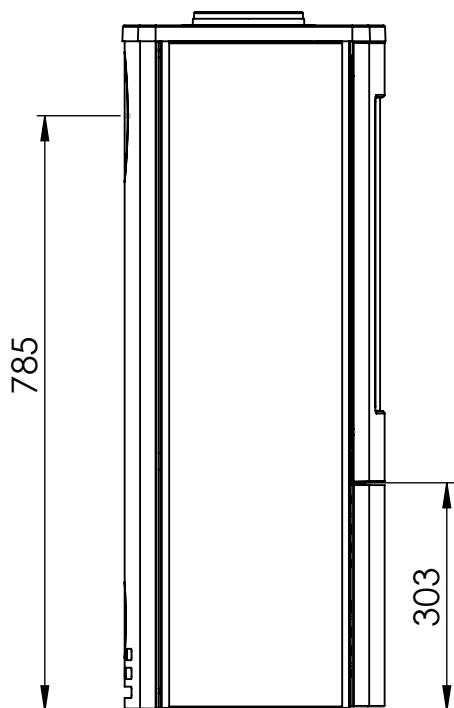
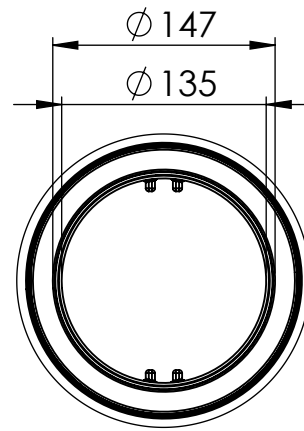
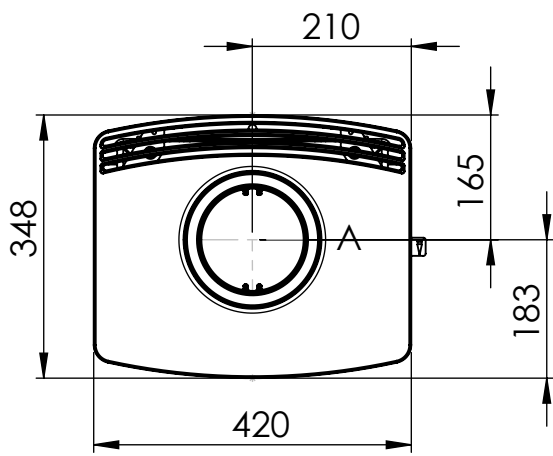