

Uno 2 =mm

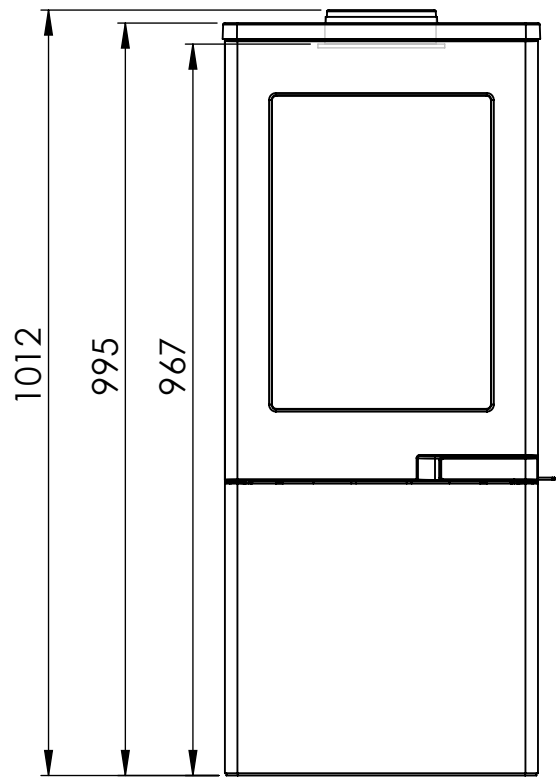

Uno 2 =mm AIR

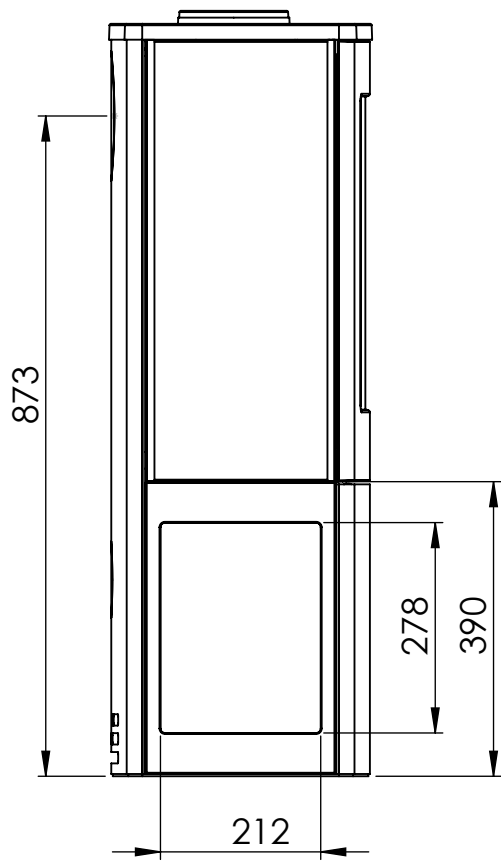
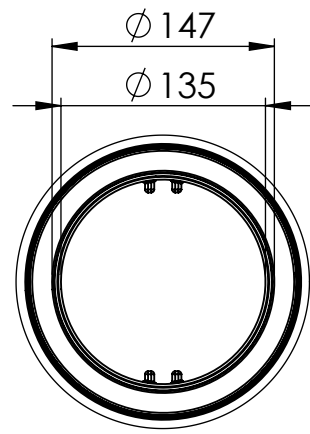
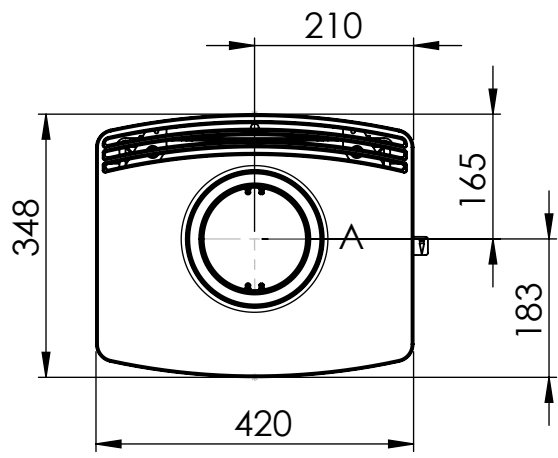